

Code	Description
<input checked="" type="checkbox"/> 201	Wall panels TENAX W (50 to 250 mm) with EPS or MW insulation
<input type="checkbox"/> 401-1	Sealing tape, one-side self adhering, thickness t=3 mm, width b=30 mm
<input type="checkbox"/> 411-1	Construction sealant (butil sealant, white color)
<input type="checkbox"/> 411-2	EPDM gasket (factory installed)
<input type="checkbox"/> 501-1	Screws for panel fastening, self-drilling, for steel structures with web thickness up to 12 mm (c/c ≤ 500 mm)
<input type="checkbox"/> 502-1	Screws for panel fastening, for timber structures (c/c ≤ 500 mm)
<input type="checkbox"/> 503-1	Screws for panel fastening, for concrete structures (c/c ≤ 500 mm)
<input checked="" type="checkbox"/>	Included in the supply



"TENAXPANEL" Ltd
Spodribas street 1, Dobele, LV-3701, Latvia
Phone: +371 63720957

Detail number:
SP-421-1-en

Detail name:
TENAX W (50 to 250 mm) with EPS or MW insulation.
Horizontal joint between panels - Option 1. Straight side connection. Horizontal assembly.

Detail type: Wall	Scale: 1:5	Date: January 2019
----------------------	---------------	-----------------------

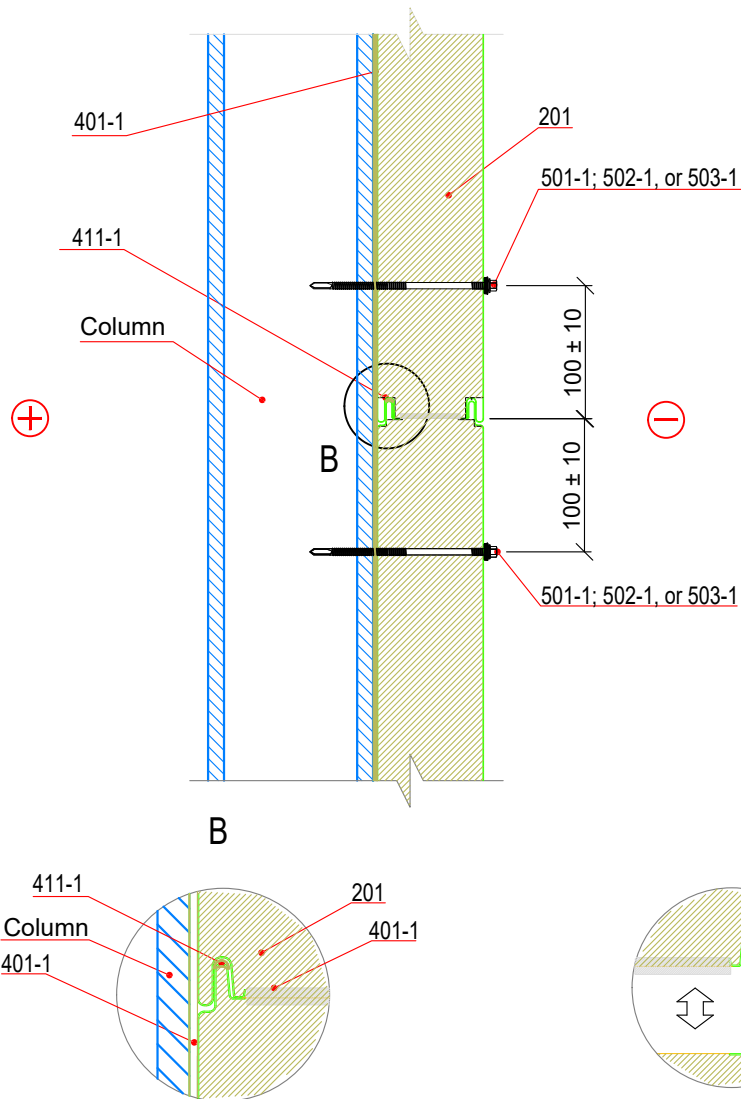

Code	Description
<input checked="" type="checkbox"/> 201	Wall panels TENAX W (50 mm to 80 mm) with PUR or PIR insulation
<input type="checkbox"/> 401-1	Sealing tape, one-side self adhering, thickness t=3 mm, width b=30 mm
<input type="checkbox"/> 411-1	Construction sealant (Outside neutral silicone/inside butil sealant, white color)
<input type="checkbox"/> 501-1	Screws for panel fastening, self-drilling, for steel structures with web thickness up to 12 mm (c/c ≤ 500 mm)
<input type="checkbox"/> 502-1	Screws for panel fastening, for timber structures (c/c ≤ 500 mm)
<input type="checkbox"/> 503-1	Screws for panel fastening, for concrete structures (c/c ≤ 500 mm)
<input checked="" type="checkbox"/>	Included in the supply



"TENAXPANEL" Ltd
Spodribas street 1, Dobele, LV-3701, Latvia
Phone: +371 63720957

Detail number:
SP-421-2-en

Detail name:
TENAX W (50 mm to 80 mm) with PUR or PIR insulation.
Horizontal joint between panels - Option 2. Straight side connection. Horizontal assembly.

Detail type:
Wall

Scale:
1:5

Date:
January 2019

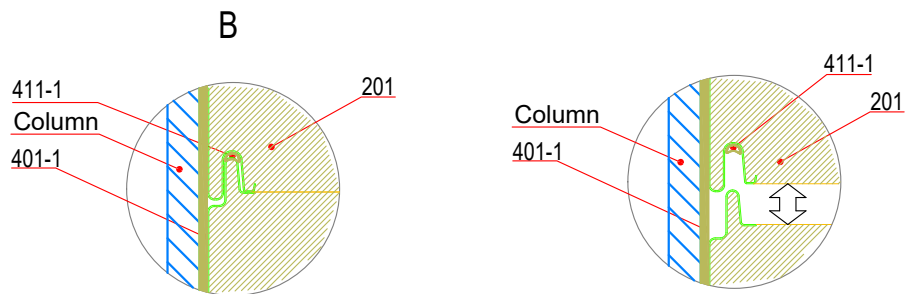
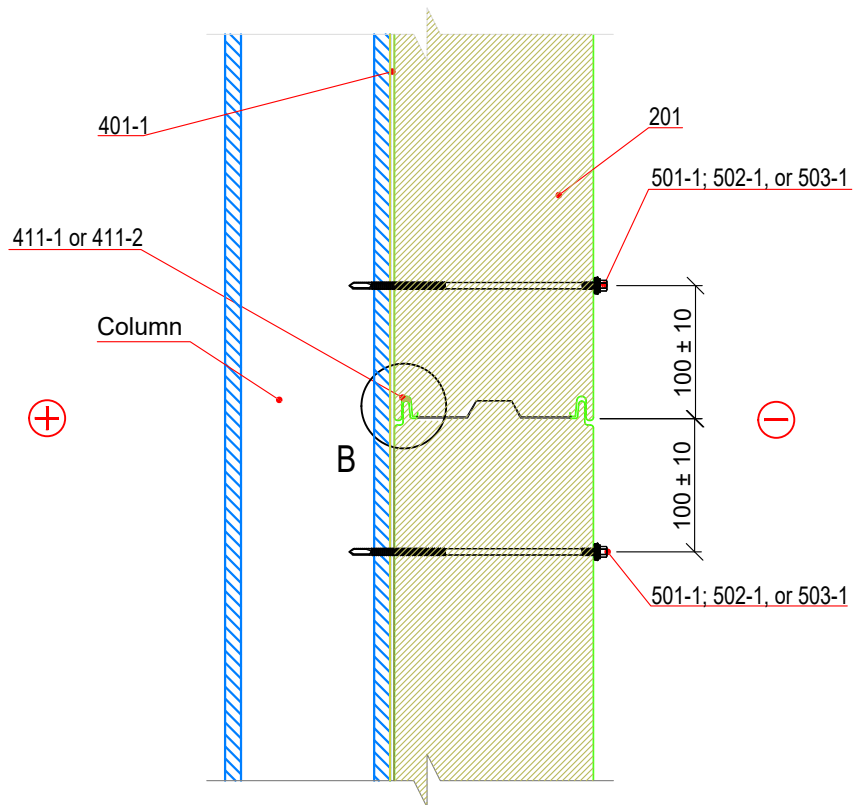

Code	Description
<input checked="" type="checkbox"/> 201	Wall panels TENAX W (100 mm) with PUR or PIR insulation
<input type="checkbox"/> 401-1	Sealing tape, one-side self adhering, thickness t=3 mm, width b=30 mm
<input type="checkbox"/> 411-1	Construction sealant (Outside neutral silicone/inside butil sealant, white color)
<input type="checkbox"/> 411-2	EPDM gasket (factory installed)
<input type="checkbox"/> 501-1	Screws for panel fastening, self-drilling, for steel structures with web thickness up to 12 mm (c/c ≤ 500 mm)
<input type="checkbox"/> 502-1	Screws for panel fastening, for timber structures (c/c ≤ 500 mm)
<input type="checkbox"/> 503-1	Screws for panel fastening, for concrete structures (c/c ≤ 500 mm)
<input checked="" type="checkbox"/>	Included in the supply



"TENAXPANEL" Ltd
Spodribas street 1, Dobeles, LV-3701, Latvia
Phone: +371 63720957

Detail number:
SP-421-3-en

Detail name:
TENAX W (100 mm) with PUR or PIR insulation.
Horizontal joint between panels - Option 3. Thermolock
side connection. Horizontal assembly.

Detail type: Wall	Scale: 1:5	Date: January 2019
----------------------	---------------	-----------------------

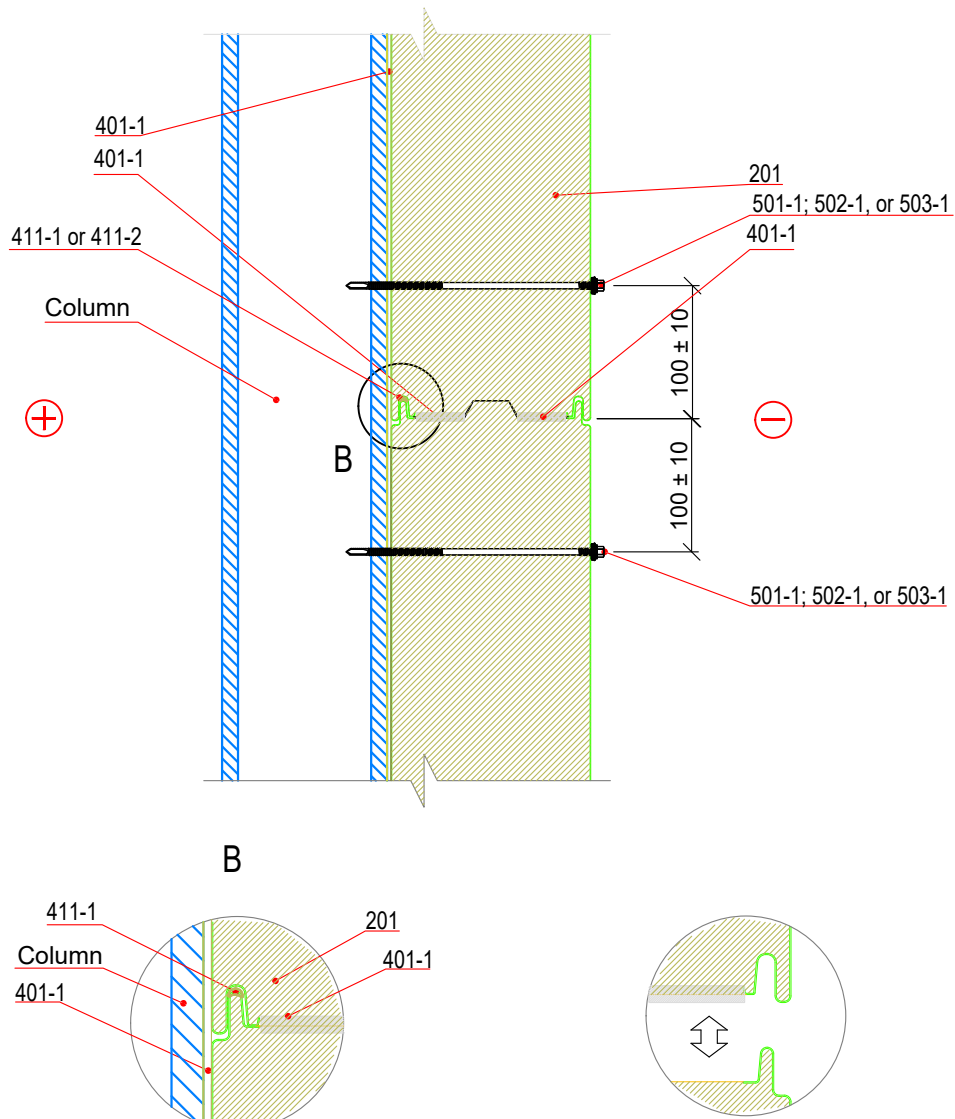

Code	Description
<input checked="" type="checkbox"/> 201	Wall panels TENAX W (120 to 220 mm) with PUR or PIR insulation
<input type="checkbox"/> 401-1	Sealing tape, one-side self adhering, thickness t=3 mm, width b=30 mm
<input type="checkbox"/> 411-1	Construction sealant (Outside neutral silicone/inside butil sealant, white color)
<input type="checkbox"/> 411-2	EPDM gasket (factory installed)
<input type="checkbox"/> 501-1	Screws for panel fastening, self-drilling, for steel structures with web thickness up to 12 mm (c/c ≤ 500 mm)
<input type="checkbox"/> 502-1	Screws for panel fastening, for timber structures (c/c ≤ 500 mm)
<input type="checkbox"/> 503-1	Screws for panel fastening, for concrete structures (c/c ≤ 500 mm)
<input checked="" type="checkbox"/>	Included in the supply



"TENAXPANEL" Ltd
Spodribas street 1, Dobele, LV-3701, Latvia
Phone: +371 63720957

Detail number:
SP-421-4-en

Detail name:
TENAX W(120 to 220 mm) with PUR or PIR insulation.
Horizontal joint between panels - Option 4. Thermolock
side connection and sealing tape. Horizontal assembly.

Detail type: Wall	Scale: 1:5	Date: January 2019
----------------------	---------------	-----------------------

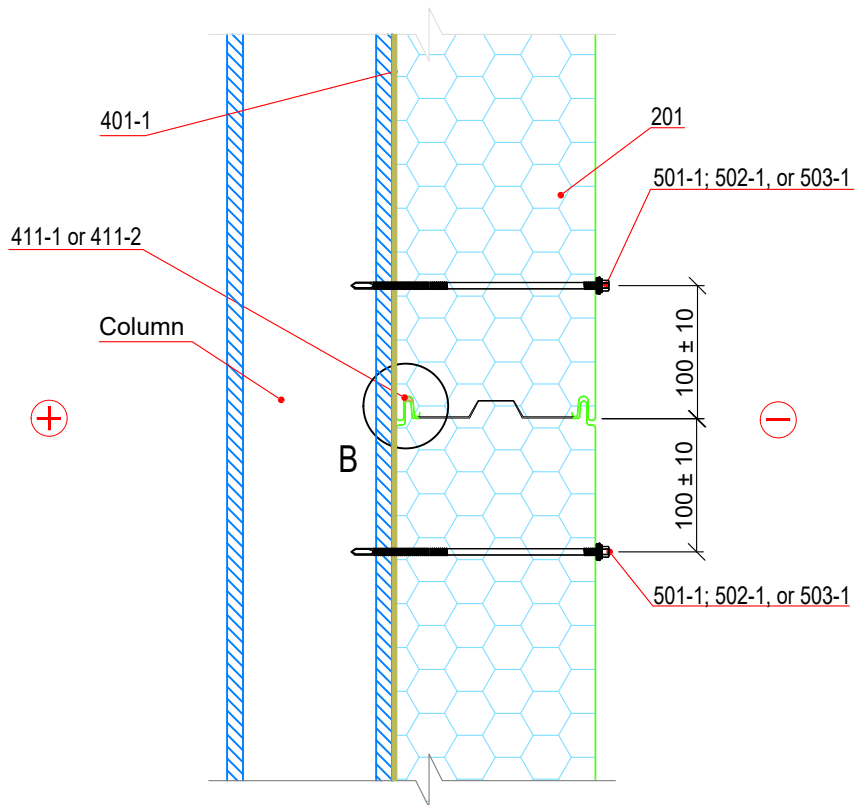

B

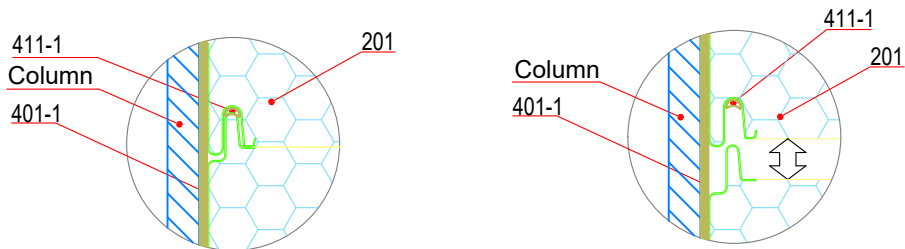

Code	Description
<input checked="" type="checkbox"/> 201	Wall panels TENAX W (120 to 220 mm) with MW insulation
<input type="checkbox"/> 401-1	Sealing tape, one-side self adhering, thickness t=3 mm, width b=30 mm
<input type="checkbox"/> 411-1	Construction sealant (Outside neutral silicone/inside butil sealant, white color)
<input type="checkbox"/> 411-2	EPDM gasket (factory installed)
<input type="checkbox"/> 501-1	Screws for panel fastening, self-drilling, for steel structures with web thickness up to 12 mm (c/c ≤ 500 mm)
<input type="checkbox"/> 502-1	Screws for panel fastening, for timber structures (c/c ≤ 500 mm)
<input type="checkbox"/> 503-1	Screws for panel fastening, for concrete structures (c/c ≤ 500 mm)
<input checked="" type="checkbox"/>	Included in the supply



"TENAXPANEL" Ltd
Spodribas street 1, Dobele, LV-3701, Latvia
Phone: +371 63720957

Nosaukums:
TENAX W(120 to 220 mm) with MW insulation.
Horizontal joint between panels - Option 4. Thermolock
side connection and sealing tape. Horizontal assembly.

Rasējuma numurs:
SP-421-5-en

Izstrādājuma veids:
Wall

Mērogs:
1:5

Datums:
January 2019

Copyright of TENAXPANEL Ltd. allowed to be used only for installation of products manufactured by TENAXPANEL Ltd. Designer is responsible for any changes in details!

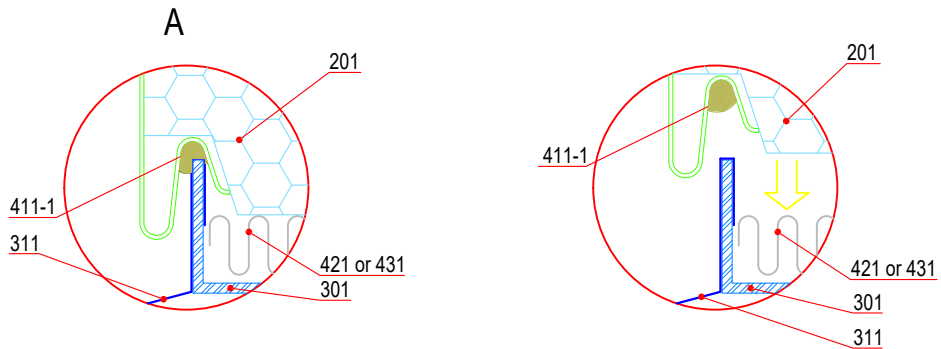
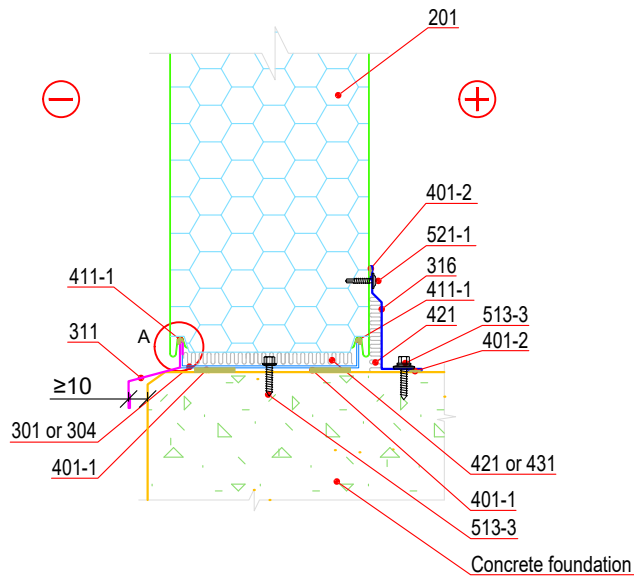

Code	Description
<input checked="" type="checkbox"/> 201	Wall panels TENAX W
<input type="checkbox"/> 301	Support profile, UB (For mineral wool and EPS panels)
<input type="checkbox"/> 304	Support profile, UP (For PUR and PIR panels)
<input type="checkbox"/> 311	Plinth drip nose, BF (install prior to panel)
<input type="checkbox"/> 316	Skirting, KF
<input type="checkbox"/> 401-1	Sealing tape, one-side self adhering, thickness t=3 mm, width b=30 mm
<input type="checkbox"/> 401-2	Sealing tape, one-side self adhering, thickness t=3 mm, width b=9 mm
<input type="checkbox"/> 411-1	Construction sealant (Outside neutral silicone/inside butil sealant, white color)
<input type="checkbox"/> 421	Mineral wool, in strips
<input type="checkbox"/> 431	Installation foam
<input type="checkbox"/> 513-3	Screws for fixing of details to concrete structure (c/c ≤ 500 mm)
<input type="checkbox"/> 521-1	Screws for fixing of flashings to panels (c/c ≤ 500 mm)
<input checked="" type="checkbox"/>	Included in the supply

UB profile has to be installed 10 ± 1 mm from column



"TENAXPANEL" Ltd
Spodribas street 1, Dobeles, LV-3701, Latvia
Phone: +371 63720957

Detail number:
SP-403-1-en

Detail name:
TENAX W. Fixing to concrete foundation - Option 1

Detail type: Wall	Scale: 1:5	Date: January 2019
----------------------	---------------	-----------------------

Code	Description
311	Plinth drip nose, BF (install prior to panel)

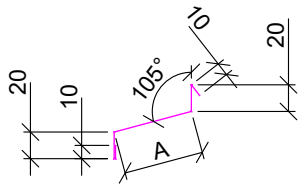

Steel sheet thickness 0,5; 0,6 mm
 Coating: the same as panel coating
 Length: 2,4 to 3,0 m

A*	40	60	80
Steel sheet width	103	123	143

* Other widths possible by individual request

Code	Description
301	Support profile, UB (For mineral wool and EPS panels)

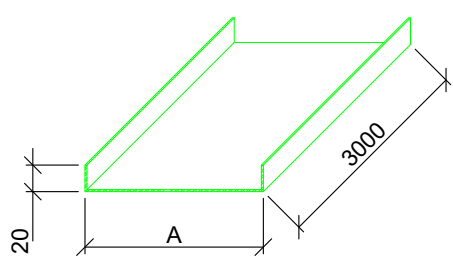

Steel sheet thickness 1,5 mm
 Coating: Zinc Z275
 Length: 3,0 m

Panel thickness	50	80	100	120	150	175	200	240	300
A*	34	64	84	104	134	159	184	224	284
Steel sheet width	74	104	124	144	174	199	224	264	324

Code	Description
304	Support profile, UP (For PUR and PIR panels)

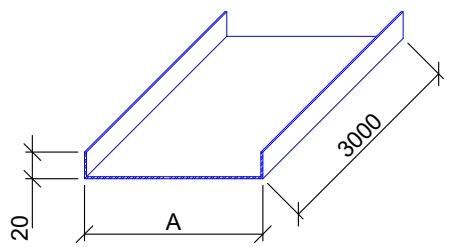

Steel sheet thickness 1,5 mm
 Coating: Zinc Z275
 Length: 3,0 m

Panel thickness	50	80	100	120	150	175	200	220
A*	32	62	81	101	129	154	178	198
Steel sheet width	72	102	121	141	169	194	218	238

* Other widths possible by individual request

Code	Description
316	Skirting, KF

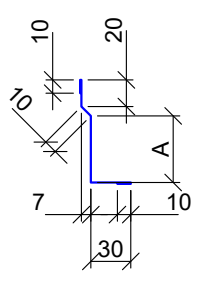

Steel sheet thickness 0,5; 0,6 mm
 Coating: the same as panel coating
 Length: 2,4 to 3,0 m

A*	50	60	80
Steel sheet width	132	142	162

* Other widths possible by individual request

Copyright of TENAXPANEL Ltd. allowed to be used only for installation of products manufactured by TENAXPANEL Ltd. Designer is responsible for any changes in details!



"TENAXPANEL" Ltd
 Spodribas street 1, Dobeles, LV-3701, Latvia
 Phone: +371 63720957

Detail number:
SP-403-1-en

Detail name:
 TENAX W. Fixing to concrete foundation - Option 1
 (Flashings)

Detail type:	Wall	Scale:	1:5	Date:	January 2019
--------------	------	--------	-----	-------	--------------

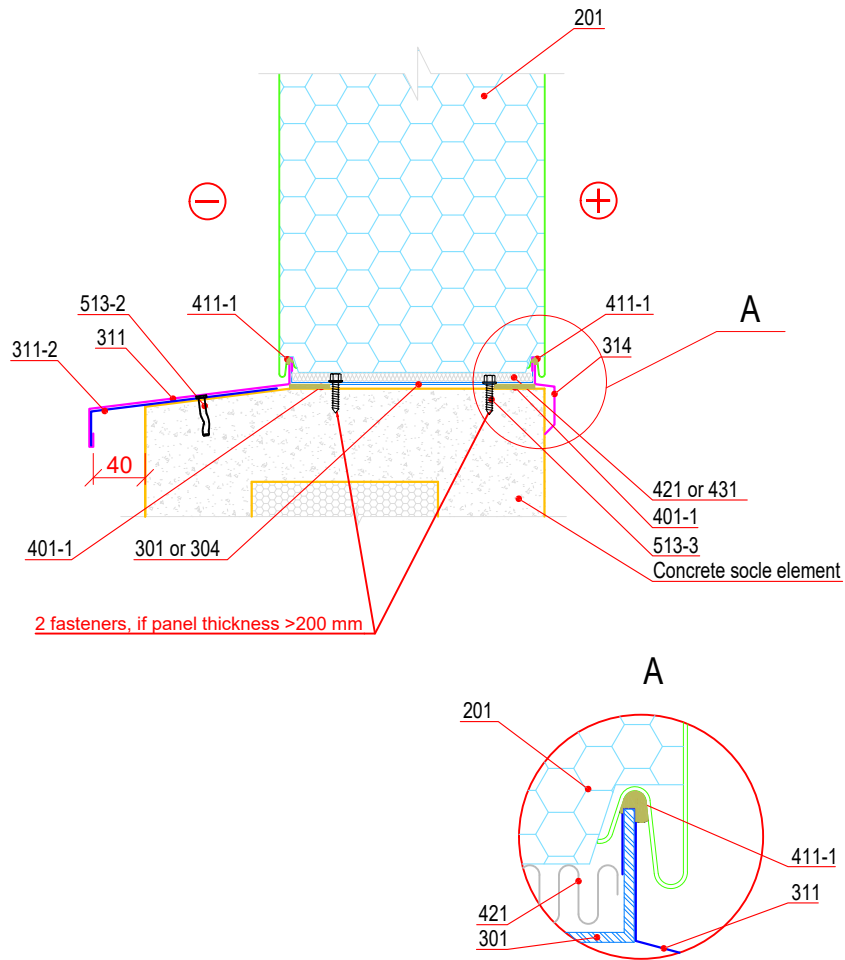

Code	Description
<input checked="" type="checkbox"/> 201	Wall panels TENAX W
<input type="checkbox"/> 301	Support profile, UB (For mineral wool and EPS panels)
<input type="checkbox"/> 304	Support profile, UP (For PUR and PIR panels)
<input type="checkbox"/> 311	Plinth drip nose, BF (install prior to panel)
<input type="checkbox"/> 311-2	Plinth drip nose support
<input type="checkbox"/> 314	Plinth drip nose, BF2 (install prior to panel)
<input type="checkbox"/> 401-1	Sealing tape, one-side self adhering, thickness t=3 mm, width b=30 mm
<input type="checkbox"/> 411-1	Construction sealant (Outside neutral silicone/inside butil sealant, white color)
<input type="checkbox"/> 421	Mineral wool, in strips
<input type="checkbox"/> 431	Installation foam
<input type="checkbox"/> 513-2	Spike DT-6.3x38
<input type="checkbox"/> 513-3	Screws for fixing of details to concrete structure (c/c ≤ 500 mm)
<input checked="" type="checkbox"/>	Included in the supply

UB profile has to be installed 10 ± 1 mm from column



"TENAXPANEL" Ltd
Spodribas street 1, Dobele, LV-3701, Latvia
Phone: +371 63720957

Detail number:
SP-403-2-en

Detail name:
TENAX W. Fixing to concrete foundation - Option 2

Detail type: Wall	Scale: 1:5	Date: January 2019
----------------------	---------------	-----------------------

Code	Description
301	Support profile, UB (For mineral wool and EPS panels)

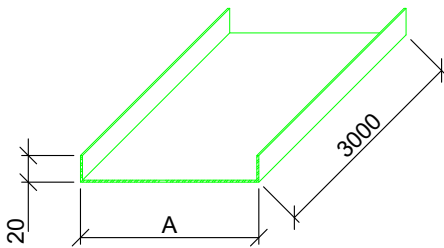

Steel sheet thickness 1,5 mm
Coating: Zinc Z275
Length: 3,0 m

Panel thickness	50	80	100	120	150	175	200	240	300
A*	34	64	84	104	134	159	184	224	284
Steel sheet width	74	104	124	144	174	199	224	264	324

* Other widths possible by individual request

Code	Description
304	Support profile, UP (For PUR and PIR panels)

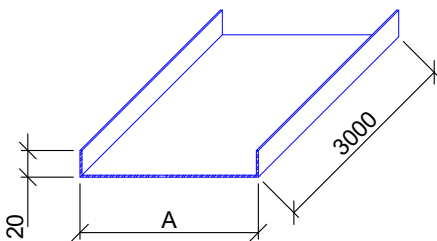

Steel sheet thickness 1,5 mm
Coating: Zinc Z275
Length: 3,0 m

Panel thickness	50	80	100	120	150	175	200	220
A*	32	62	81	101	129	154	178	198
Steel sheet width	72	102	121	141	169	194	218	238

* Other widths possible by individual request

Code	Description
311	Plinth drip nose, BF (install prior to panel)

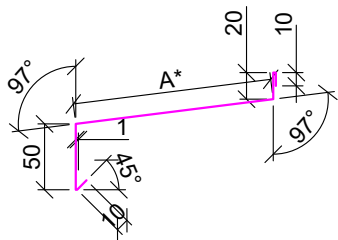

A*	40	60	80
Steel sheet width	103	123	143

* Other widths possible by individual request

Code	Description
311-2	Plinth drip nose support

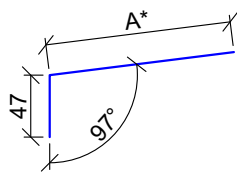

Steel sheet thickness 0,5; 0,6 mm
Coating: the same as panel coating
Length: 2.4 m

* Other widths possible by individual request

Code	Description
314	Plinth drip nose, BF2 (install prior to panel)

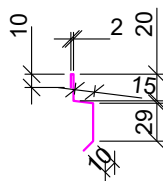

Steel sheet thickness 0,5; 0,6 mm
Coating: the same as panel coating
Length: 2.4 m

* Other widths possible by individual request



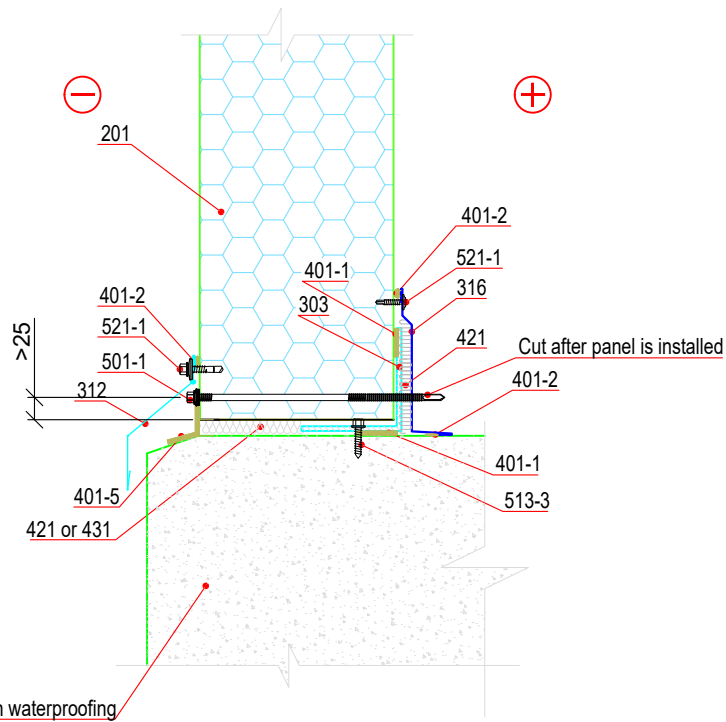

Code	Description
<input checked="" type="checkbox"/> 201	Wall panels TENAX W
<input type="checkbox"/> 303	Support profile, UL
<input type="checkbox"/> 312	Plinth drip nose, PF
<input type="checkbox"/> 316	Skirting, KF
<input type="checkbox"/> 401-1	Sealing tape, one-side self adhering, thickness t=3 mm, width b=30 mm
<input type="checkbox"/> 401-2	Sealing tape, one-side self adhering, thickness t=3 mm, width b=9 mm
<input type="checkbox"/> 401-5	Acrylic sealing tape, b=60mm
<input type="checkbox"/> 421	Mineral wool, in strips
<input type="checkbox"/> 431	Installation foam
<input type="checkbox"/> 501-1	Screws for panel fastening, self-drilling, for steel structures with web thickness up to 12 mm (c/c ≤ 500 mm)
<input type="checkbox"/> 513-3	Screws for fixing of details to concrete structure (c/c ≤ 500 mm)
<input type="checkbox"/> 521-1	Screws for fixing of flashings to panels (c/c ≤ 500 mm)
<input checked="" type="checkbox"/>	Included in the supply

- (a) For steel structures with web thickness t>12mm predrill holes for screw (501) fixing
 (b) The given support width can vary depending on wind loads



"TENAXPANEL" Ltd
 Spodribas street 1, Dobele, LV-3701, Latvia
 Phone.:+371 63720957

Detail number:
 SP-403-3-en

Detail name:
 TENAX W. Vertical assembly.
 Fixing to concrete foundation - Option 3

Detail type: Wall	Scale: 1:5	Date: January 2019
----------------------	---------------	-----------------------

Code	Description
303	Support profile, UL

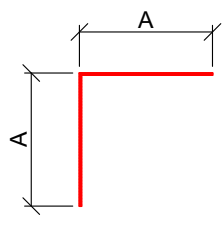

Steel sheet thickness 1,5 - 3 mm
 Coating: Zinc Z275
 Length: 3,0 m

A	50	75	100	125	150	200
Steel sheet width	100	150	200	250	300	400

Code	Description
312	Plinth drip nose, PF

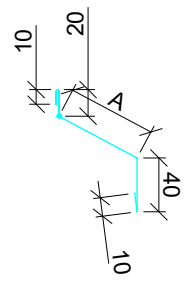

Steel sheet thickness 0,5; 0,6 mm
 Coating: the same as panel coating
 Length: 2,4 to 3,0 m

A*	50	80	100	120	150	200
Steel sheet width	130	160	180	200	230	280

* Other widths possible by individual request

Code	Description
316	Skirting, KF

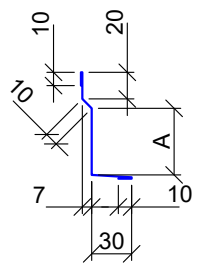

Steel sheet thickness 0,5; 0,6 mm
 Coating: the same as panel coating
 Length: 2,4 m

A*	50	60	80
Steel sheet width	132	142	162

* Other widths possible by individual request

Copyright of TENAXPANEL Ltd. allowed to be used only for installation of products manufactured by TENAXPANEL Ltd. Designer is responsible for any changes in details!



"TENAXPANEL" Ltd
 Spodribas street 1, Dobeles, LV-3701, Latvia
 Phone: +371 63720957

Detail name:
 TENAX W. Vertical assembly.
 Fixing to concrete foundation - Option 3 (Flashings)

Detail number:
 SP-403-3-en

Detail type: Wall	Scale: 1:5	Date: January 2019
----------------------	---------------	-----------------------

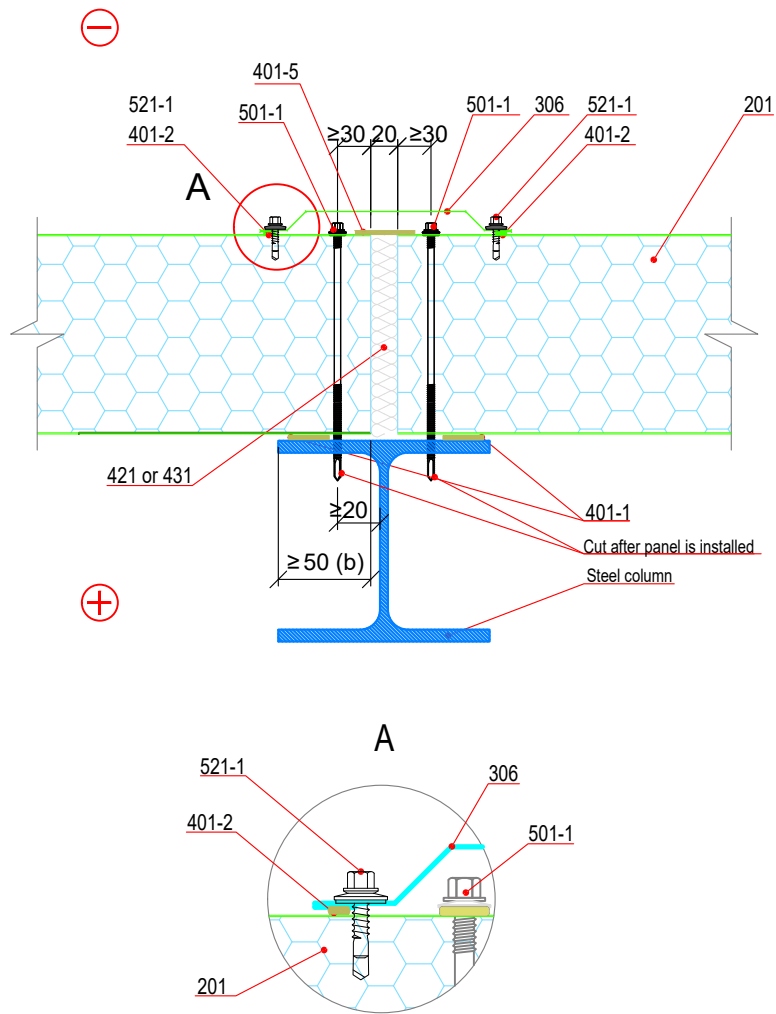

Code	Description
<input checked="" type="checkbox"/> 201	Wall panels TENAX W
<input type="checkbox"/> 306	Butt joint flashing for wall panels, AF
<input type="checkbox"/> 401-1	Sealing tape, one-side self adhering, thickness t=3 mm, width b=30 mm
<input type="checkbox"/> 401-2	Sealing tape, one-side self adhering, thickness t=3 mm, width b=9 mm
<input type="checkbox"/> 401-5	Acrylic sealing tape, b=60mm
<input type="checkbox"/> 421	Mineral wool, in strips
<input type="checkbox"/> 431	Installation foam
<input type="checkbox"/> 501-1	Screws for panel fastening, self-drilling, for steel structures with web thickness up to 12 mm (c/c ≤ 500 mm)
<input type="checkbox"/> 521-1	Screws for fixing of flashings to panels (c/c ≤ 500 mm)
<input checked="" type="checkbox"/>	Included in the supply

- (a) For steel structures with web thickness t>12mm predrill holes for screw (501) fixing
 (b) The given support width can vary depending on wind loads



"TENAXPANEL" Ltd
 Spodribas street 1, Dobeles, LV-3701, Latvia
 Phone: +371 63720957

Detail number:
SP-412-1-en

Detail name:

TENAX W.
 Fixing to steel column in length - Option 1

Detail type:

Wall

Scale:
 1:5

Date:
 January 2019

Code	Description
306	Butt joint flashing for wall panels, AF

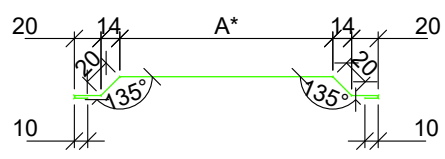



Steel sheet thickness 0,5; 0,6 mm
 Coating: the same as panel coating
 Length: 2,4 m

A*	80	120	160
Steel sheet width	180	220	260

* Other widths possible by individual request

Copyright of TENAXPANEL Ltd. allowed to be used only for installation of products manufactured by TENAXPANEL Ltd. Designer is responsible for any changes in details!

 	"TENAXPANEL" Ltd Spodribas street 1, Dobele, LV-3701, Latvia Phone: +371 63720957	Detail name: TENAX W. Fixing to steel column in length - Option 1 (Flashings)		
	Detail number: SP-412-1-en	Detail type: Wall	Scale: 1:5	Date: January 2019

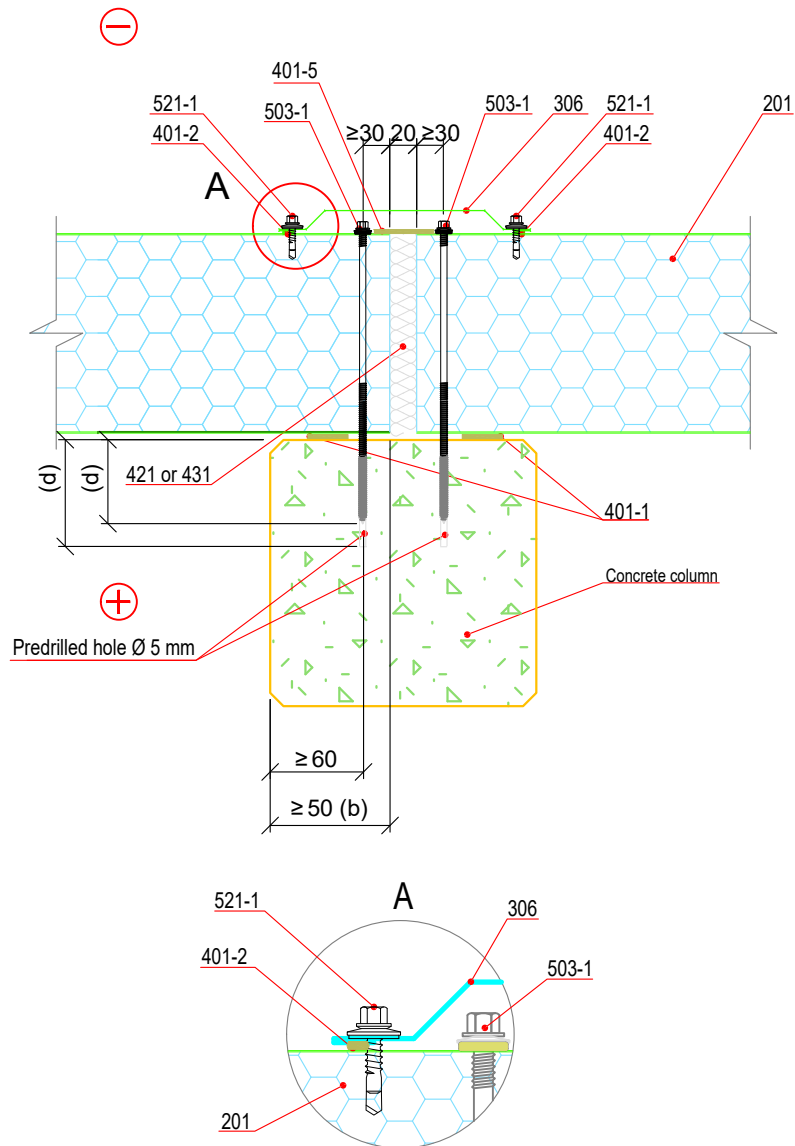

Code	Description
<input checked="" type="checkbox"/> 201	Wall panels TENAX W
<input type="checkbox"/> 306	Butt joint flashing for wall panels, AF
<input type="checkbox"/> 401-1	Sealing tape, one-side self adhering, thickness t=3 mm, width b=30 mm
<input type="checkbox"/> 401-2	Sealing tape, one-side self adhering, thickness t=3 mm, width b=9 mm
<input type="checkbox"/> 401-5	Acrylic sealing tape, b=60mm
<input type="checkbox"/> 421	Mineral wool, in strips
<input type="checkbox"/> 431	Installation foam
<input type="checkbox"/> 503-1	Screws for panel fastening, for concrete structures (c/c ≤ 500 mm)
<input type="checkbox"/> 521-1	Screws for fixing of flashings to panels (c/c ≤ 500 mm)
<input checked="" type="checkbox"/>	Included in the supply

(b) The given support width can vary depending on wind loads
 (d) See specification of fasteners manufacturer



"TENAXPANEL" Ltd
 Spodribas street 1, Dobele, LV-3701, Latvia
 Phone: +371 63720957

Detail number:
 SP-413-1-en

Detail name:
 TENAX W.
 Fixing to concrete column in length - Option 1

Detail type: Wall	Scale: 1:5	Date: January 2019
----------------------	---------------	-----------------------

Code	Description
306	Butt joint flashing for wall panels, AF

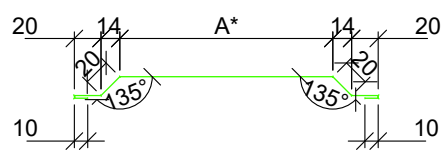



Steel sheet thickness 0,5; 0,6 mm
 Coating: the same as panel coating
 Length: 2,4 m

A*	80	120	160
Steel sheet width	180	220	260

* Other widths possible by individual request

Copyright of TENAXPANEL Ltd. allowed to be used only for installation of products manufactured by TENAXPANEL Ltd. Designer is responsible for any changes in details!

 	"TENAXPANEL" Ltd Spodribas street 1, Dobele, LV-3701, Latvia Phone.:+371 63720957	Detail name: TENAX W. Fixing to steel column in length - Option 1(Flashings)		
	Detail number: SP-413-1-en	Detail type: Wall	Scale: 1:5	Date: January 2019

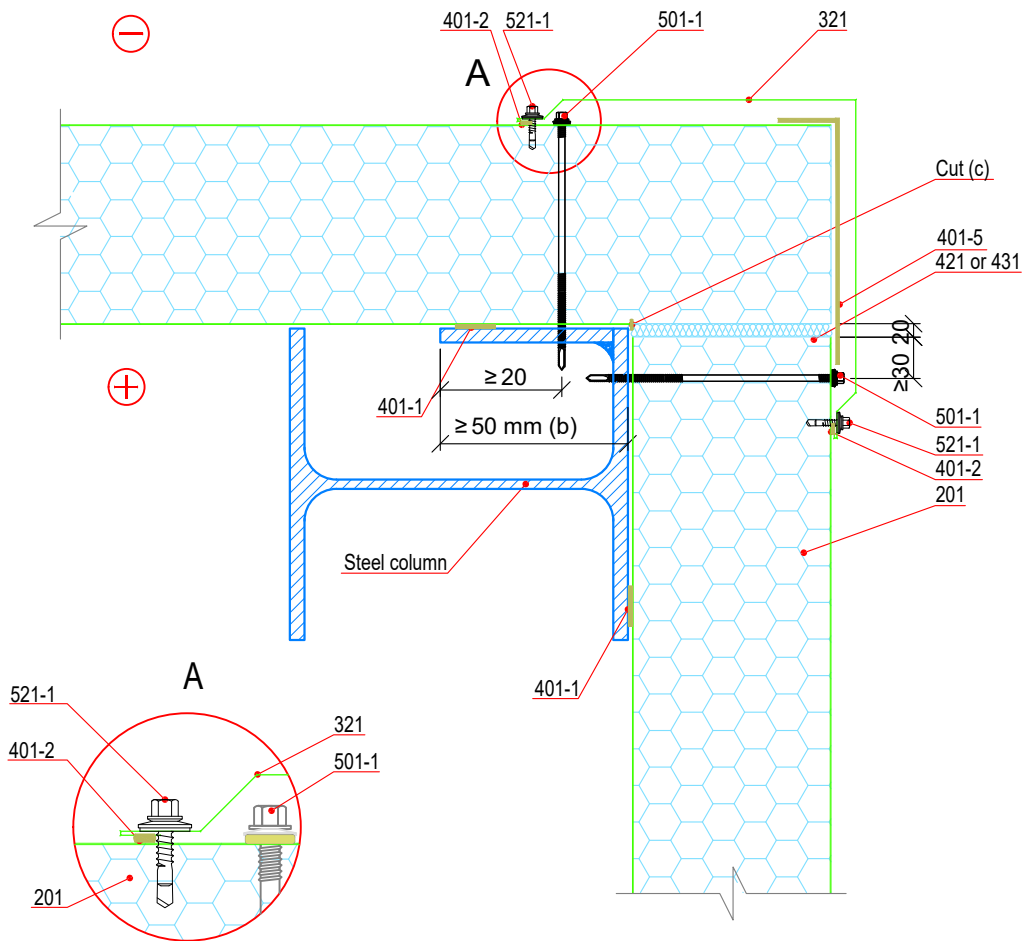

Code	Description
<input checked="" type="checkbox"/> 201	Wall panels TENAX W
<input type="checkbox"/> 321	External corner flashing, CF
<input type="checkbox"/> 401-1	Sealing tape, one-side self adhering, thickness t=3 mm, width b=30 mm
<input type="checkbox"/> 401-2	Sealing tape, one-side self adhering, thickness t=3 mm, width b=9 mm
<input type="checkbox"/> 401-5	Acrylic sealing tape, b=150mm x 2
<input type="checkbox"/> 421	Mineral wool, in strips
<input type="checkbox"/> 431	Installation foam
<input type="checkbox"/> 501-1	Screws for panel fastening, self-drilling, for steel structures with web thickness up to 12 mm (c/c ≤ 500 mm)
<input type="checkbox"/> 521-1	Screws for fixing of flashings to panels (c/c ≤ 500 mm)
<input checked="" type="checkbox"/>	Included in the supply

- (a) For steel structures with web thickness $t > 12$ mm predrill holes for screw (501) fixing
 (b) The given support width can vary depending on wind loads
 (c) Cut for thermal break at the distance from panel end equal to panel thickness



"TENAXPANEL" Ltd
 Spodribas street 1, Dobeles, LV-3701, Latvia
 Phone: +371 63720957

Detail number:
SP-414-1-en

Detail name:

TENAX W. Fixing to steel column at external corner - Option 1

Detail type:

Wall

Scale:
 1:5

Date:
 January 2019

Code	Description
321	External corner flashing, CF

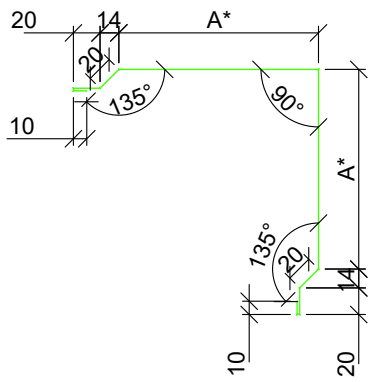

Steel sheet thickness 0,5; 0,6 mm
 Coating: the same as panel coating
 Length: 2,4 m

Panel thickness	50	80	100	120	150	175	200	240	300
A*	120	150	170	190	220	245	270	310	370
Steel sheet width	340	400	440	480	540	590	640	720	840

* Other widths possible by individual request

Copyright of TENAXPANEL Ltd. allowed to be used only for installation of products manufactured by TENAXPANEL Ltd. Designer is responsible for any changes in details!



"TENAXPANEL" Ltd
 Spodribas street 1, Dobeles, LV-3701, Latvia
 Phone: +371 63720957

Detail name:
 TENAX W. Fixing to concrete foundation - Option 1(Flashings)

Detail number:
 SP-414-1-en

Detail type: Wall	Scale: 1:5	Date: January 2019
----------------------	---------------	-----------------------

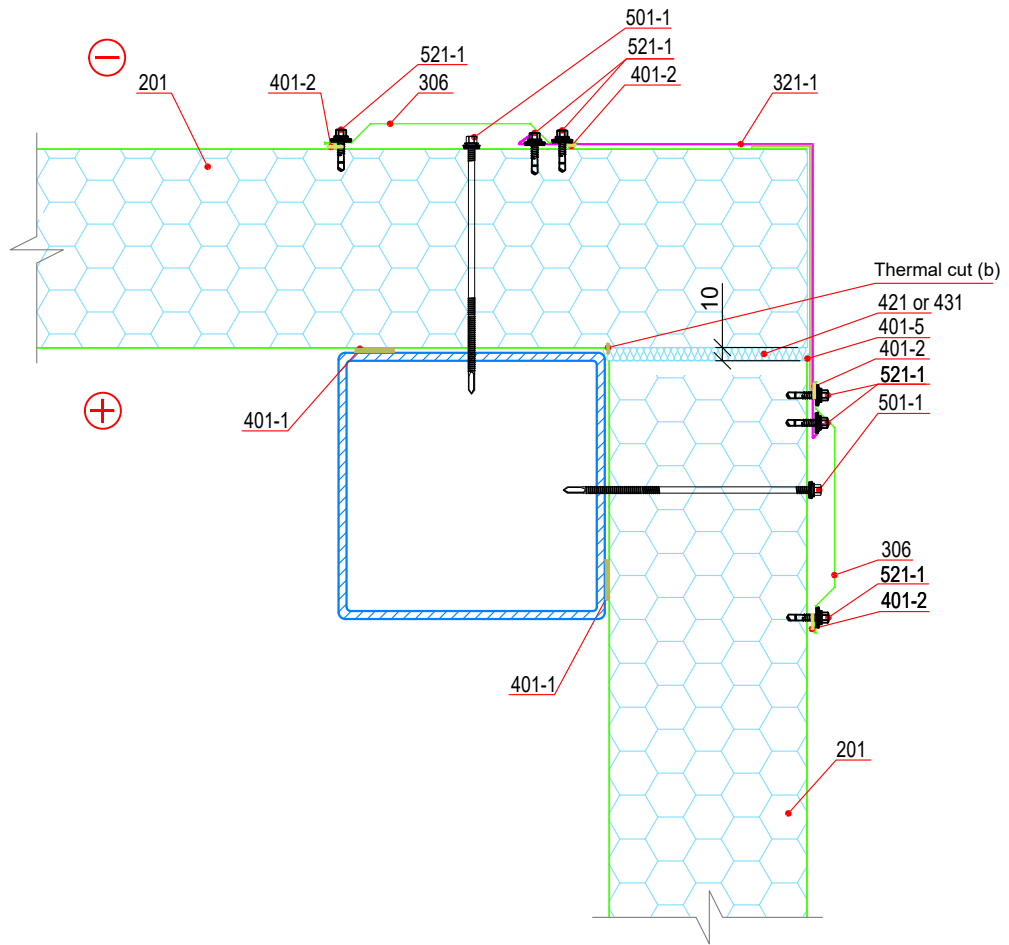

Code Description

<input checked="" type="checkbox"/>	201	Wall panels TENAX W
<input type="checkbox"/>	306	Butt joint flashing for wall panels, AF
<input type="checkbox"/>	321-1	External corner flashing, ECF
<input type="checkbox"/>	401-1	Sealing tape, one-side self adhering, thickness t=3 mm, width b=30 mm
<input type="checkbox"/>	401-2	Sealing tape, one-side self adhering, thickness t=3 mm, width b=9 mm
<input type="checkbox"/>	401-5	Acrylic sealing tape, b=150mm x 2
<input type="checkbox"/>	411-1	Construction sealant (neutral)
<input type="checkbox"/>	421	Mineral wool, in strips
<input type="checkbox"/>	501-1	Screws for panel fastening, self-drilling, for steel structures with web thickness up to 12 mm (c/c ≤ 500 mm)
<input type="checkbox"/>	521-1	Screws for fixing of flashings to panels (c/c ≤ 500 mm) In colour of the flashing
<input type="checkbox"/>	531-1	Rivets for fixing of flashings to panels, with organic coating (c/c ≤ 300 mm)
<input checked="" type="checkbox"/>		Included in the supply

(a) For steel structures with web thickness $t > 12$ mm predrill holes for screw (501) fixing

(b) Cut for thermal break at the distance from panel end equal to panel thickness

Code	Description
306	Butt joint flashing for wall panels, AF

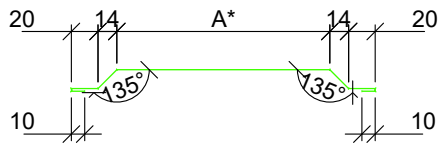

Steel sheet thickness 0,5; 0,6 mm
 Coating: the same as panel coating
 Length: 2,4 m

A*	80	120	160
Steel sheet width	184	224	264

* Other widths possible by individual request

Code	Description
321-1	External corner flashing, ECF

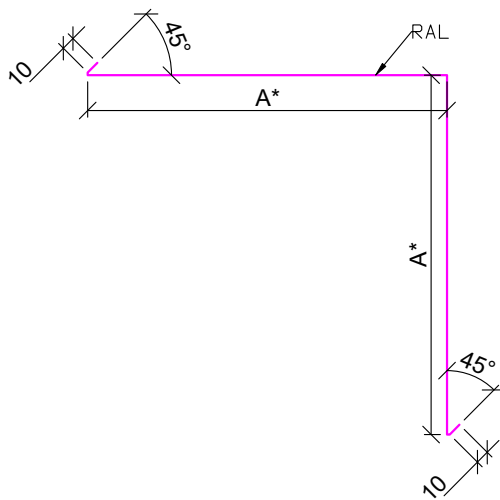

Steel sheet thickness 0,5; 0,6 mm
 Coating: the same as panel coating
 Length: 2,4 m

Panel thickness	150	175	200	240	300
A*	170	195	220	260	320
Steel sheet width	465	515	565	645	765

* Other widths possible by individual request

Copyright of TENAXPANEL Ltd. allowed to be used only for installation of products manufactured by TENAXPANEL Ltd. Designer is responsible for any changes in details!



"TENAXPANEL" Ltd
 Spodribas street 1, Dobele, LV-3701, Latvia
 Phone: +371 63720957

Detail number:
 SP-414-2-en

Detail name:

TENAX W. Fixing to concrete foundation - Option 2
 (Flashings)

Detail type:
 Horizontal Facade

Scale:
 1:5

Date:
 January 2019

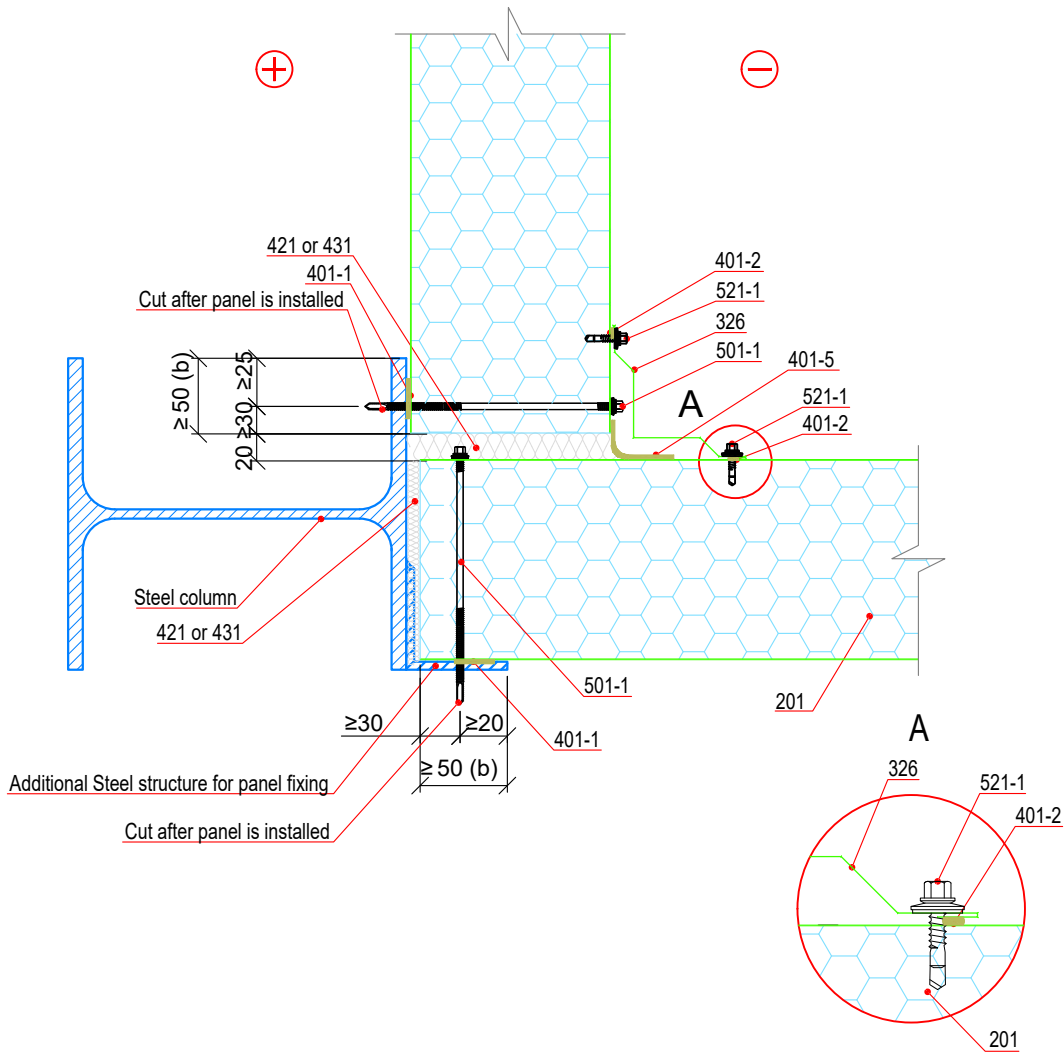

Code	Description
<input checked="" type="checkbox"/> 201	Wall panels TENAX W
<input type="checkbox"/> 326	Internal corner flashing, IF
<input type="checkbox"/> 401-1	Sealing tape, one-side self adhering, thickness t=3 mm, width b=30 mm
<input type="checkbox"/> 401-2	Sealing tape, one-side self adhering, thickness t=3 mm, width b=9 mm
<input type="checkbox"/> 401-5	Acrylic sealing tape, b=60mm
<input type="checkbox"/> 411-1	Construction sealant (neutral)
<input type="checkbox"/> 421	Mineral wool, in strips
<input type="checkbox"/> 431	Installation foam
<input type="checkbox"/> 501-1	Screws for panel fastening, self-drilling, for steel structures with web thickness up to 12 mm (c/c ≤ 500 mm)
<input type="checkbox"/> 521-1	Screws for fixing of flashings to panels (c/c ≤ 500 mm)

- Included in the supply
- (a) For steel structures with web thickness t>12mm predrill holes for screw (501) fixing
- (b) The given support width can vary depending on wind loads



"TENAXPANEL" Ltd
Spodribas street 1, Dobele, LV-3701, Latvia
Phone: +371 63720957

Detail number:
SP-417-1-en

Detail name:
TENAX W. Fixing to steel column at internal corner.

Detail type: Wall	Scale: 1:5	Date: January 2019
----------------------	---------------	-----------------------

Code	Description
326	Internal corner flashing, IF

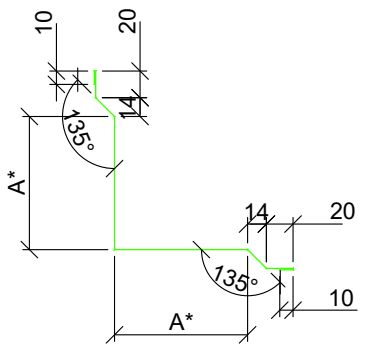



Steel sheet thickness 0,5; 0,6 mm
 Coating: the same as panel coating
 Length: 2,4 m

A*	50	100	150
Steel sheet width	200	300	400

* Other widths possible by individual request

Copyright of TENAXPANEL Ltd. allowed to be used only for installation of products manufactured by TENAXPANEL Ltd. Designer is responsible for any changes in details!

 	"TENAXPANEL" Ltd Spodribas street 1, Dobeles, LV-3701, Latvia Phone: +371 63720957	Detail name: TENAX W. Fixing to steel column at internal corner - Option 1(Flashings)		
	Detail number: SP-417-1-en	Detail type: Wall	Scale: 1:5	Date: January 2019

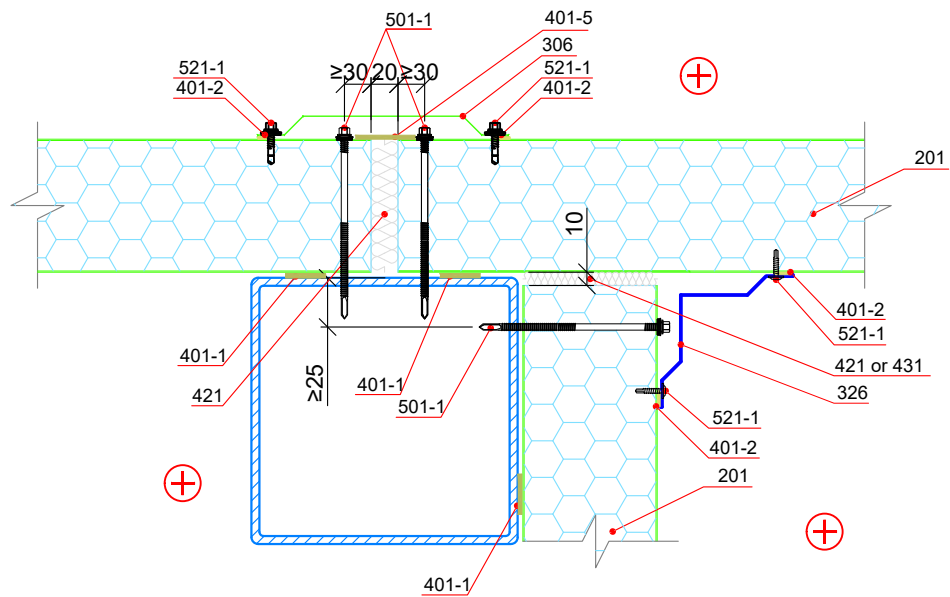

Code	Description
<input checked="" type="checkbox"/> 201	Wall panels TENAX W
<input type="checkbox"/> 306	Butt joint flashing for wall panels, AF
<input type="checkbox"/> 326	Internal corner flashing, IF
<input type="checkbox"/> 401-1	Sealing tape, one-side self adhering, thickness t=3 mm, width b=30 mm
<input type="checkbox"/> 401-2	Sealing tape, one-side self adhering, thickness t=3 mm, width b=9 mm
<input type="checkbox"/> 401-5	Acrylic sealing tape, b=60mm
<input type="checkbox"/> 421	Mineral wool, in strips
<input type="checkbox"/> 431	Installation foam
<input type="checkbox"/> 501-1	Screws for panel fastening, self-drilling, for steel structures with web thickness up to 12 mm (c/c ≤ 500 mm)
<input type="checkbox"/> 521-1	Screws for fixing of flashings to panels (c/c ≤ 500 mm)
<input type="checkbox"/> 531-1	Rivets for fixing of flashings to panels, with organic coating (c/c ≤ 300 mm)
<input checked="" type="checkbox"/>	Included in the supply

- (a) For steel structures with web thickness t>12mm predrill holes for screw (501) fixing
 (b) The given support width can vary depending on wind loads



"TENAXPANEL" Ltd
 Spodribas street 1, Dobeles, LV-3701, Latvia
 Phone: +371 63720957

Detail number:
 SP-418-1-en

Detail name:

TENAX W.
 Fixing to steel column in length, internal wall - Option 1

Detail type:

Wall

Scale:
 1:5

Date:
 January 2019

Code	Description
306	Butt joint flashing for wall panels, AF

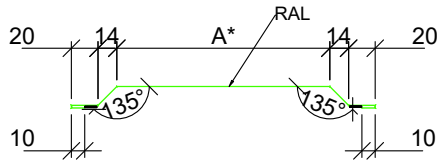

Steel sheet thickness 0,5; 0,6 mm
 Coating: the same as panel coating
 Length: 2,4 m

A*	80	120	160
Steel sheet width	180	220	260

* Other widths possible by individual request

Code	Description
326	Internal corner flashing, IF

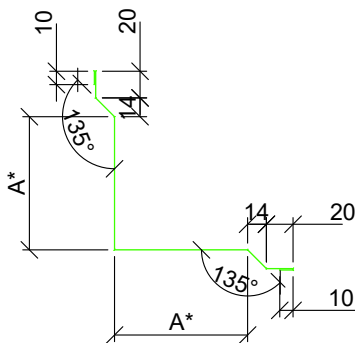

Steel sheet thickness 0,5; 0,6 mm
 Coating: the same as panel coating
 Length: 2,4 m

A*	50	100	150
Steel sheet width	200	300	400

* Other widths possible by individual request



"TENAXPANEL" Ltd
 Spodribas street 1, Dobele, LV-3701, Latvia
 Phone.:+371 63720957

Detail number:
 SP-418-1-en

Detail name:

TENAX W.
 Fixing to steel column in length, internal wall - Option 1
 (Flashings)

Detail type:

Wall

Scale:
 1:5

Date:

January 2019

Copyright of TENAXPANEL Ltd. allowed to be used only for installation of products manufactured by TENAXPANEL Ltd. Designer is responsible for any changes in details!

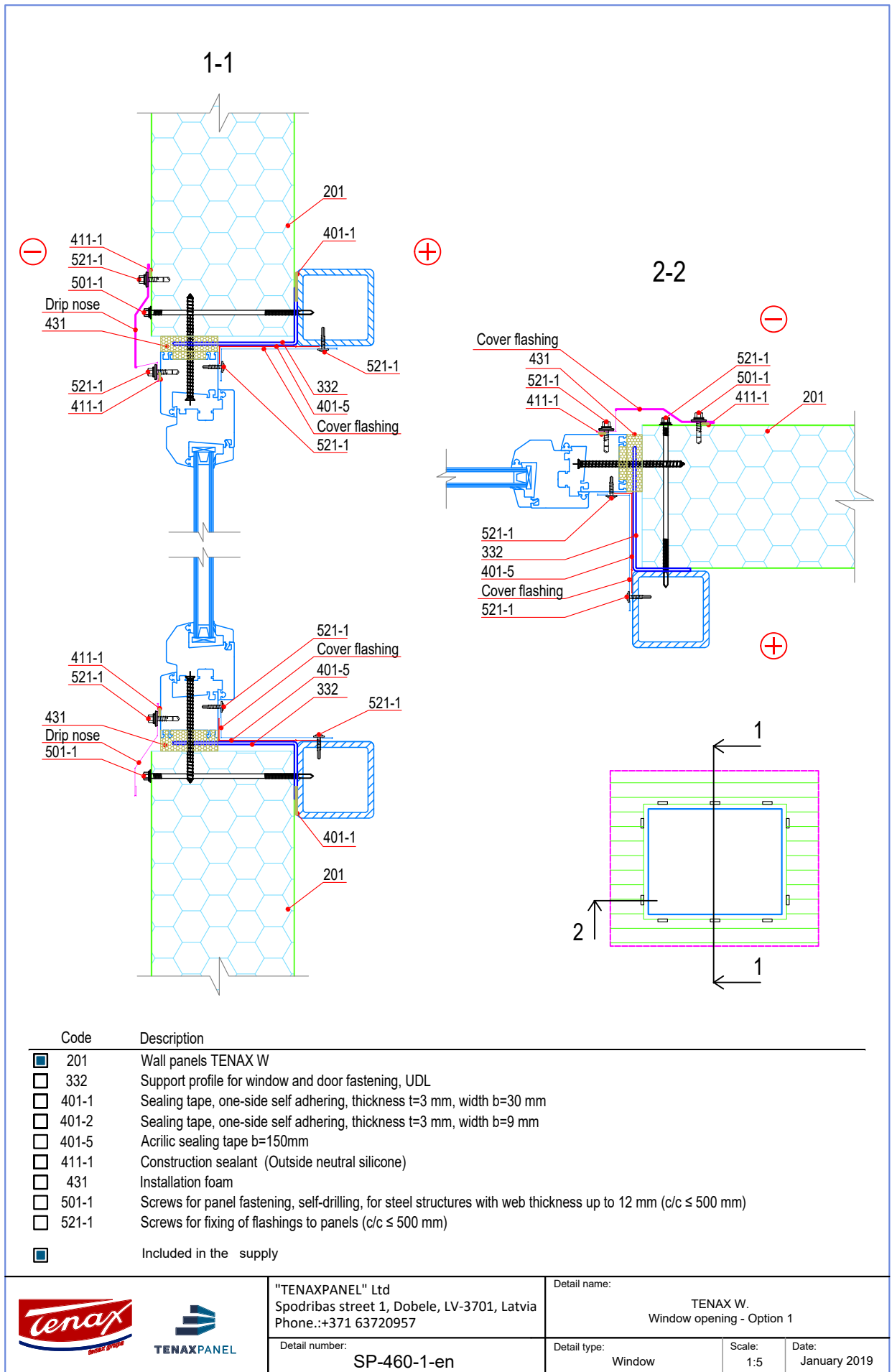

Code	Description
<input checked="" type="checkbox"/> 201	Wall panels TENAX W
<input type="checkbox"/> 332	Support profile for window and door fastening, UDL
<input type="checkbox"/> 401-1	Sealing tape, one-side self adhering, thickness t=3 mm, width b=30 mm
<input type="checkbox"/> 401-2	Sealing tape, one-side self adhering, thickness t=3 mm, width b=9 mm
<input type="checkbox"/> 401-5	Acrylic sealing tape b=150mm
<input type="checkbox"/> 411-1	Construction sealant (Outside neutral silicone)
<input type="checkbox"/> 431	Installation foam
<input type="checkbox"/> 501-1	Screws for panel fastening, self-drilling, for steel structures with web thickness up to 12 mm (c/c ≤ 500 mm)
<input type="checkbox"/> 521-1	Screws for fixing of flashings to panels (c/c ≤ 500 mm)
<input checked="" type="checkbox"/>	Included in the supply



"TENAXPANEL" Ltd
 Spodribas street 1, Dobeles, LV-3701, Latvia
 Phone: +371 63720957

Detail number:
SP-460-1-en

Detail name: TENAX W. Window opening - Option 1		
Detail type: Window	Scale: 1:5	Date: January 2019

Code	Description
332	Support profile for window and door fastening, UDL

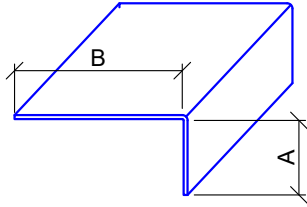

Steel sheet thickness 1,5 - 3 mm
 Coating: Zinc Z275
 Length: 0,1 m
 A and B widths possible by individual request

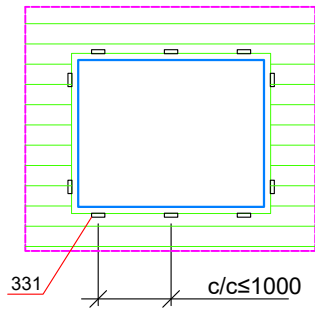

Copyright of TENAXPANEL Ltd. allowed to be used only for installation of products manufactured by TENAXPANEL Ltd. Designer is responsible for any changes in details!



"TENAXPANEL" Ltd
 Spodribas street 1, Dobele, LV-3701, Latvia
 Phone.:+371 63720957

Detail name:

TENAX W.
 Window opening - Option 1(Flashings)

Detail number:

SP-460-1-en

Detail type:

Window

Scale:

1:5

Date:

January 2019

Copyright of TENAXPANEL Ltd. allowed to be used only for installation of products manufactured by TENAXPANEL Ltd
 Designer is responsible for any changes in details!

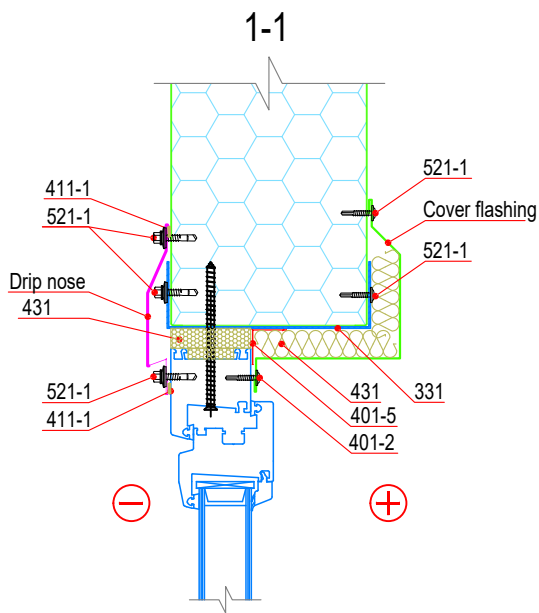

2-2

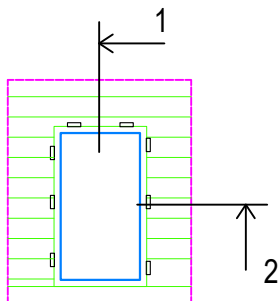
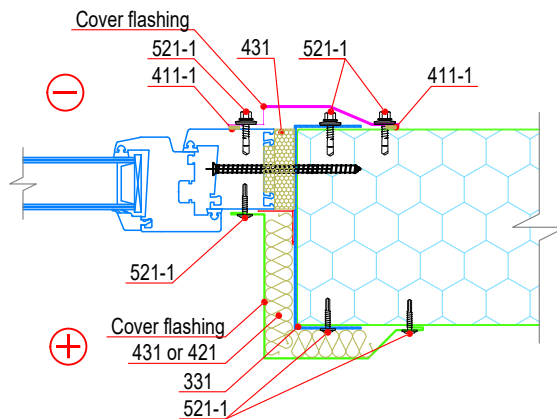

Code	Description
<input checked="" type="checkbox"/> 201	Wall panels TENAX W
<input type="checkbox"/> 331	Support profile for window and door fastening, UDA
<input type="checkbox"/> 401-2	Sealing tape, one-side self adhering, thickness t=3 mm, width b=9 mm
<input type="checkbox"/> 411-1	Construction sealant (Outside neutral silicone)
<input type="checkbox"/> 421	Mineral wool, in strips
<input type="checkbox"/> 431	Installation foam
<input type="checkbox"/> 521-1	Screws for fixing of flashings to panels (c/c ≤ 500 mm)
<input checked="" type="checkbox"/>	Included in the supply



"TENAXPANEL" Ltd
 Spodribas street 1, Dobele, LV-3701, Latvia
 Phone: +371 63720957

Detail number:
 SP-461-1-en

Detail name:

TENAX W.
 Door opening - Option 1

Detail type:
 Doors

Scale:
 1:5

Date:
 January 2019

Code	Description
331	Support profile for window and door fastening, UDA

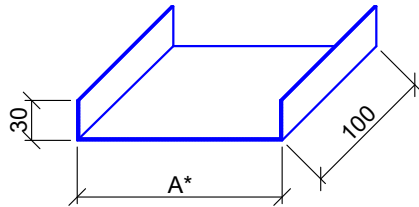

Steel sheet thickness 1,5 mm

Coating: Zinc Z275

Length: 0,1 m

Panel thickness	50	80	100	120	150	175	200	240	300
A*	54	84	104	124	154	179	204	244	304
Steel sheet width	114	144	164	184	214	239	264	304	364

* Other widths possible by individual request

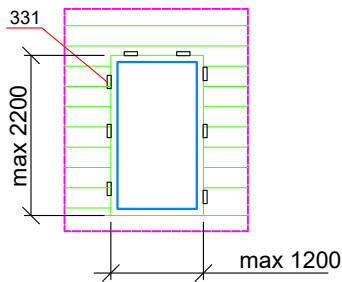

"TENAXPANEL" Ltd
Spodribas street 1, Dobele, LV-3701, Latvia
Phone.:+371 63720957

Detail number:
SP-461-1-en

Detail name:

TENAX W.
Door opening - Option 1(Flashings)

Detail type:
Doors

Scale:
1:5

Date:
January 2019

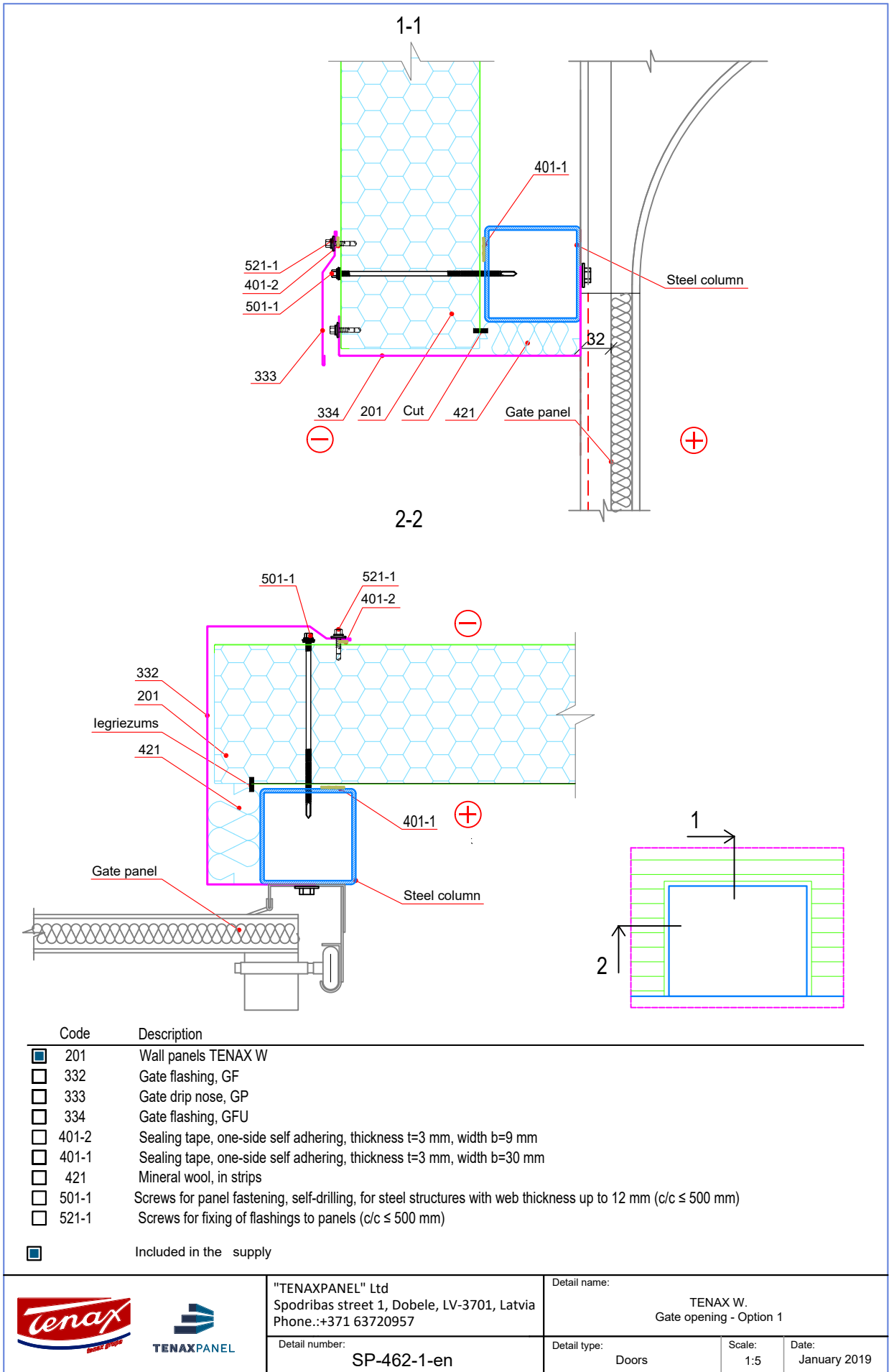

Copyright of TENAXPANEL Ltd. allowed to be used only for installation of products manufactured by TENAXPANEL Ltd
 Designer is responsible for any changes in details!

Code	Description
<input checked="" type="checkbox"/> 201	Wall panels TENAX W
<input type="checkbox"/> 332	Gate flashing, GF
<input type="checkbox"/> 333	Gate drip nose, GP
<input type="checkbox"/> 334	Gate flashing, GFU
<input type="checkbox"/> 401-2	Sealing tape, one-side self adhering, thickness t=3 mm, width b=9 mm
<input type="checkbox"/> 401-1	Sealing tape, one-side self adhering, thickness t=3 mm, width b=30 mm
<input type="checkbox"/> 421	Mineral wool, in strips
<input type="checkbox"/> 501-1	Screws for panel fastening, self-drilling, for steel structures with web thickness up to 12 mm (c/c ≤ 500 mm)
<input type="checkbox"/> 521-1	Screws for fixing of flashings to panels (c/c ≤ 500 mm)
<input checked="" type="checkbox"/>	Included in the supply



"TENAXPANEL" Ltd
 Spodribas street 1, Dobele, LV-3701, Latvia
 Phone: +371 63720957

Detail number:
SP-462-1-en

Detail name:

TENAX W.
 Gate opening - Option 1

Detail type:
 Doors

Scale:
 1:5

Date:
 January 2019

Copyright of TENAXPANEL Ltd. allowed to be used only for installation of products manufactured by TENAXPANEL Ltd. Designer is responsible for any changes in details!

Code	Description
332	Gate flashing, GF

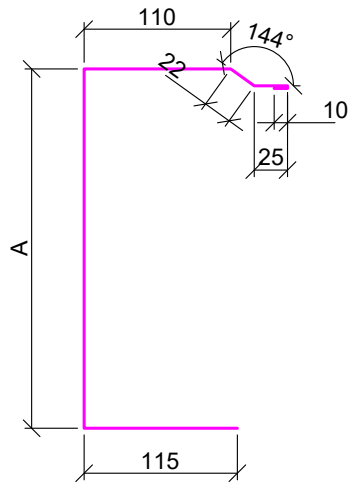

Steel sheet thickness 0,5; 0,6 mm
Coating: the same as panel coating
Length: 2,4 m

A width depend on the sonstructive solution and are prepared by individual request

Code	Description
333	Gate drip nose, GP

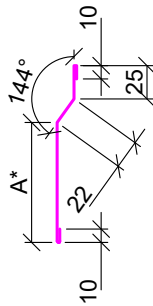

Steel sheet thickness 0,5; 0,6 mm
Coating: the same as panel coating
Length: 2,4 m

A*	50	70	90
Steel sheet width	120	140	160

* Other widths possible by individual request

Code	Description
334	Gate flashing, GFU

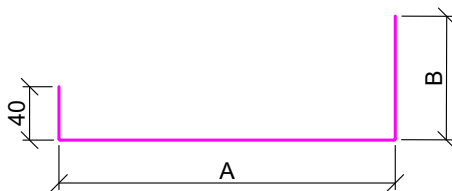

Steel sheet thickness 0,5; 0,6 mm
Coating: the same as panel coating
Length: 2,4 m

A and B widths depend on the sonstructive solution and are prepared by individual request



"TENAXPANEL" Ltd
Spodribas street 1, Dobele, LV-3701, Latvia
Phone.:+371 63720957

Detail number:
SP-462-1-en

Detail name:

TENAX W.
Gate opening - Option 1(Flashings)

Detail type:
Gates

Scale:
1:5

Date:
January 2019